

Tee-in to 9-pin Deutsch Diagnostics Connector

NOTE: increase fuse size in FRC from 5A > 7.5A

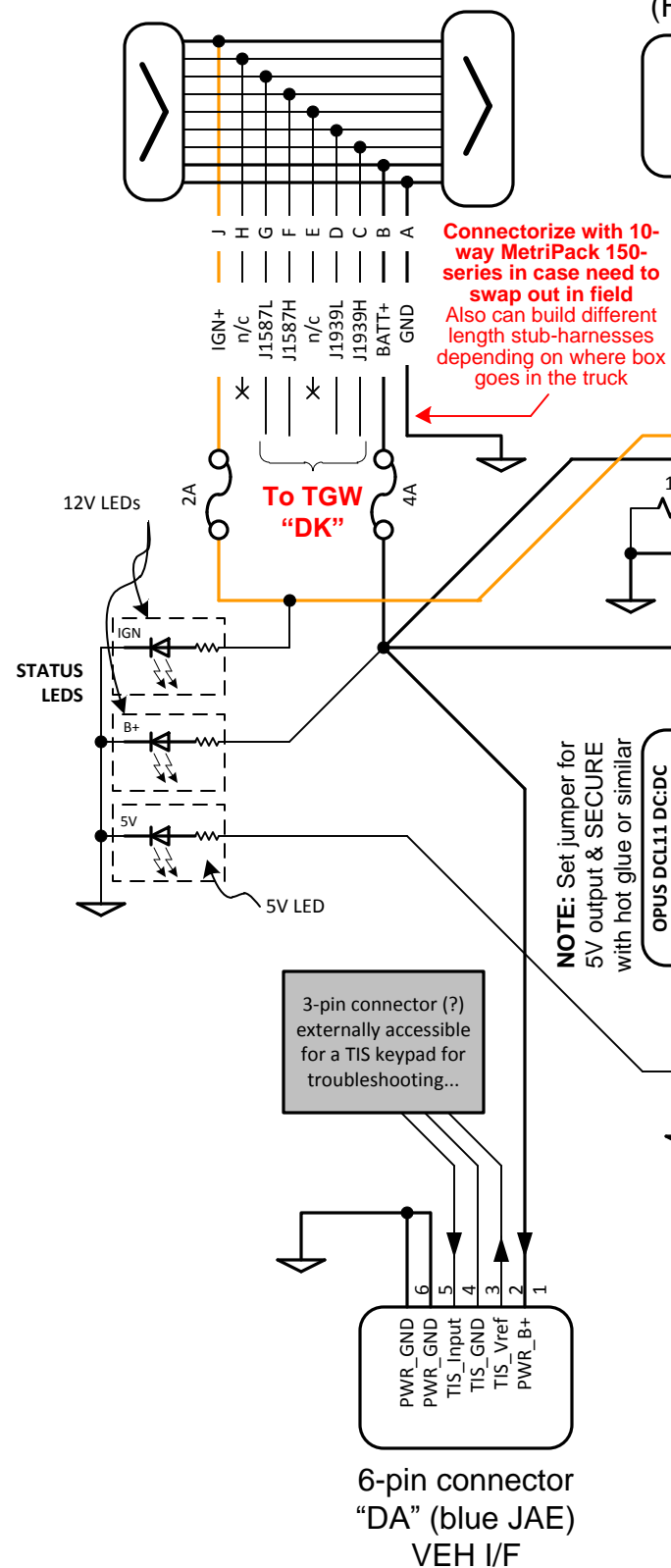

Kapsch DMCU DSRC Radio

15-pin HD15 D-sub (Female terminals on DMCU)

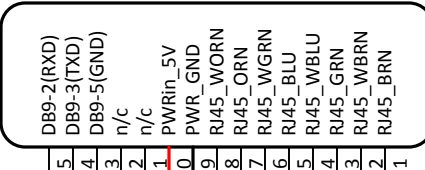

8-pin connector "DS" (Mitsumi) TGW / TTU USB

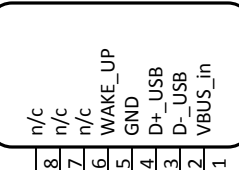

TGW Volvo PN 21284312.P03

10-pin connector "DL" (green JAE) Serial I/F

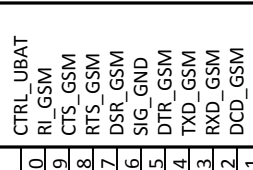

16-pin connector "DK" (green JAE) Vehicle I/F and I/O

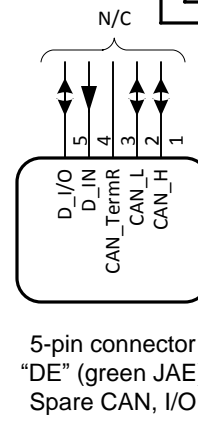
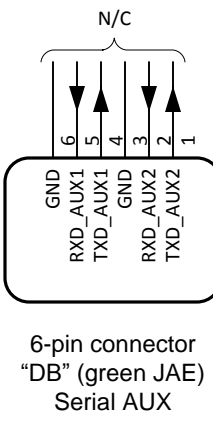
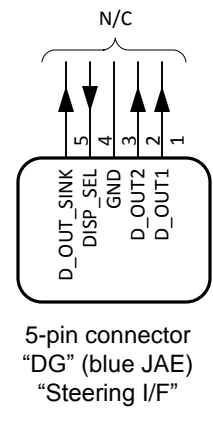
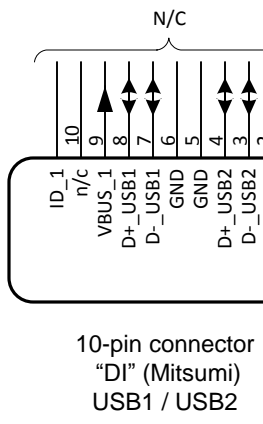
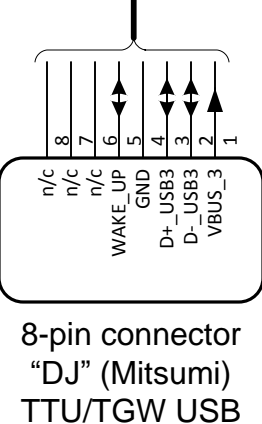
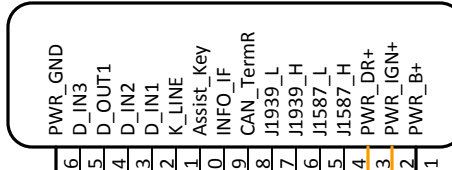

NOTE that Volvo cable does NOT have wire at pin 16 (V_SYNC) so must add to the MITSUMI connector...

VGA Display Xenarc 700TSV

26-pin I/O connector

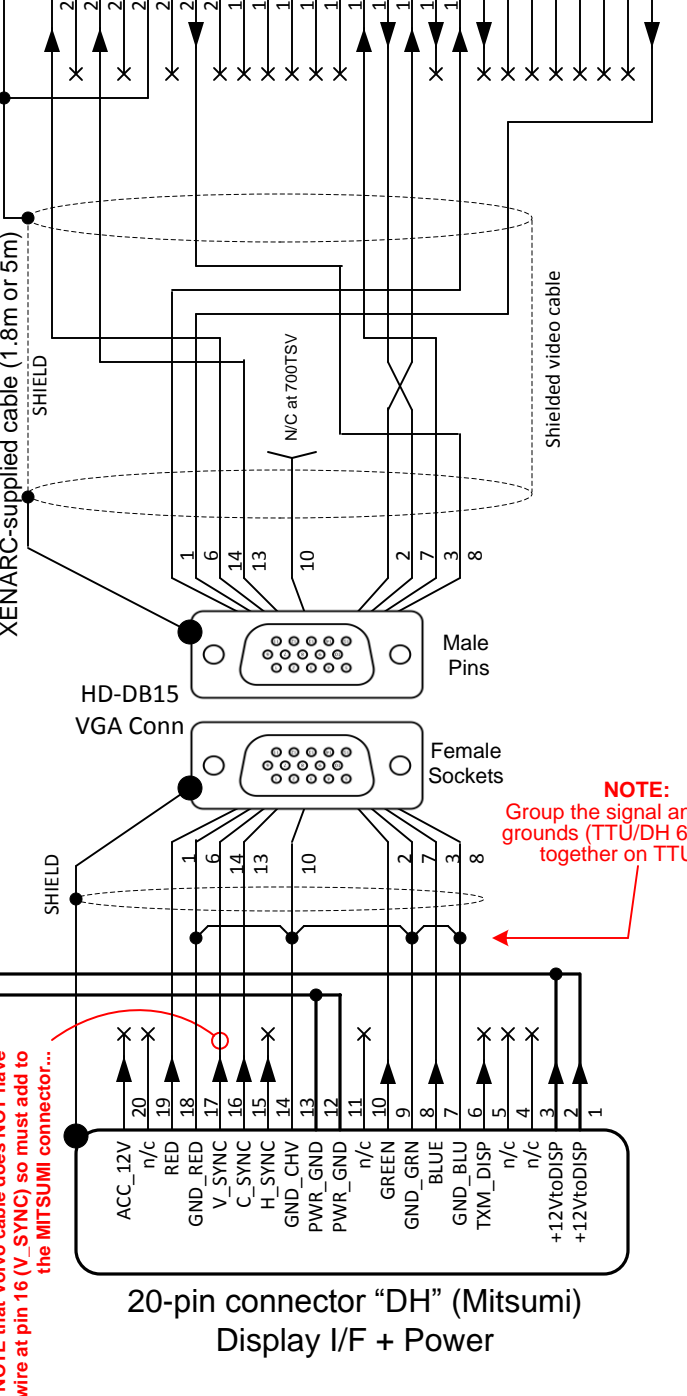

TTU Volvo PN 21034575.P04

View: Wire Insertion Side

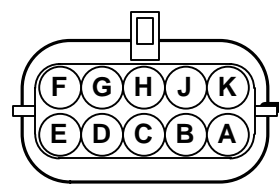

M/P 150-series 10-way
Male Terminals / Female Body
Housing: 12045808 (1 per)
Terminals: 12045773 (10 per)
Seals: 12048086 (10 per)
TPA: 12124264 (1 per)

CABLE Y

MINI-FUSE HOLDERS

4 Amp BATT+
2 Amp IGN

12V-LEDs

B+ IGN

5V-LED

5V

1KΩ R

OPUS DC11 DC:DC

Input 3-pin
Output 2-pin

TGW "DK"
16-pin green JAE

TGW "DL"
10-pin green JAE

RJ45 jack
for DMCU diags

DMCU
15-pin HD D-sub male pins

TTU "DA"
6-pin blue JAE

TIS Keypad
5-pin grnJAE

Mates to CABLE X1 or X2 (depending on truck brand)

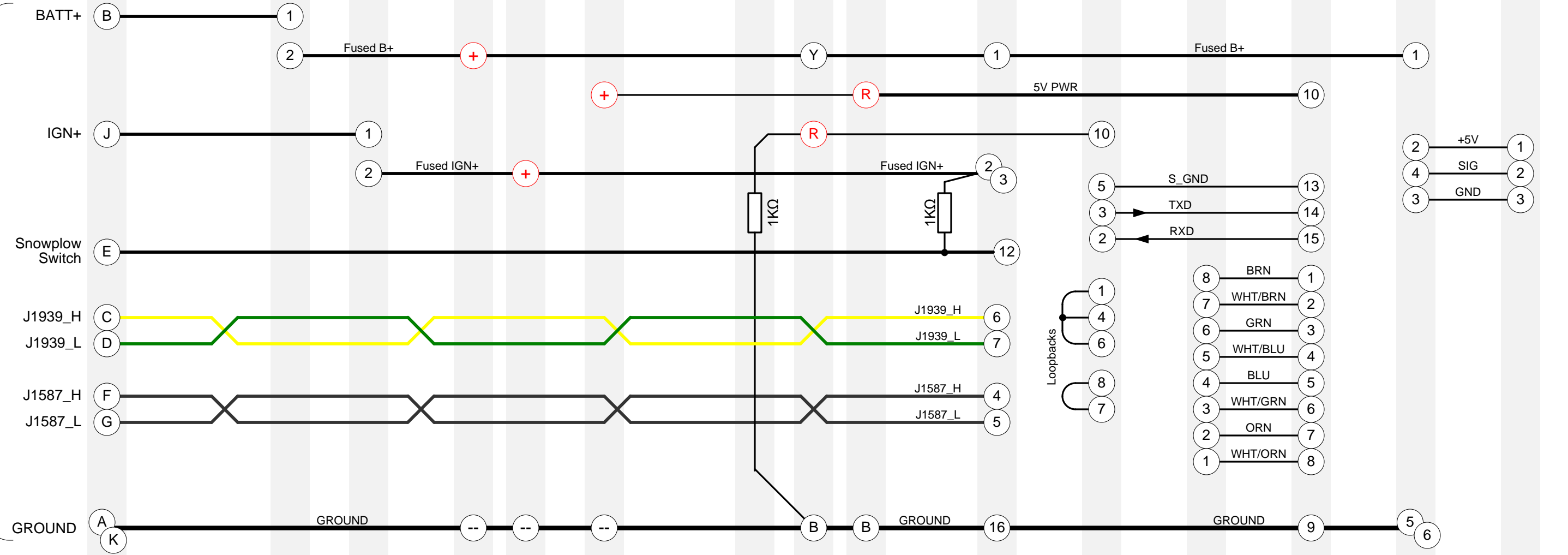

NO CONNECTION n/c (H)

Connection to the INTERNATIONAL-brand vehicles made via DIAGNOSTIC connector



HD16-9-1939S or
HD16-9-1939SE (with lock ring)

VEHICLE SIDE



HD10-9-1939S

CABLE X1

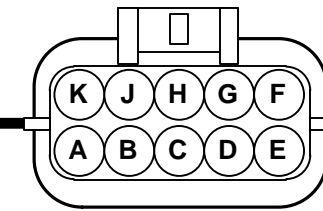

View: Wire Insertion Side

M/P 150-series 10-way
Female Terminals / Male Body

- Housing: 12065425 (1 per)
- Terminals: 12048074 (10 per)
- Seals: 12048086 (10 per)
- TPA: 12124264 (1 per)

TOOL SIDE

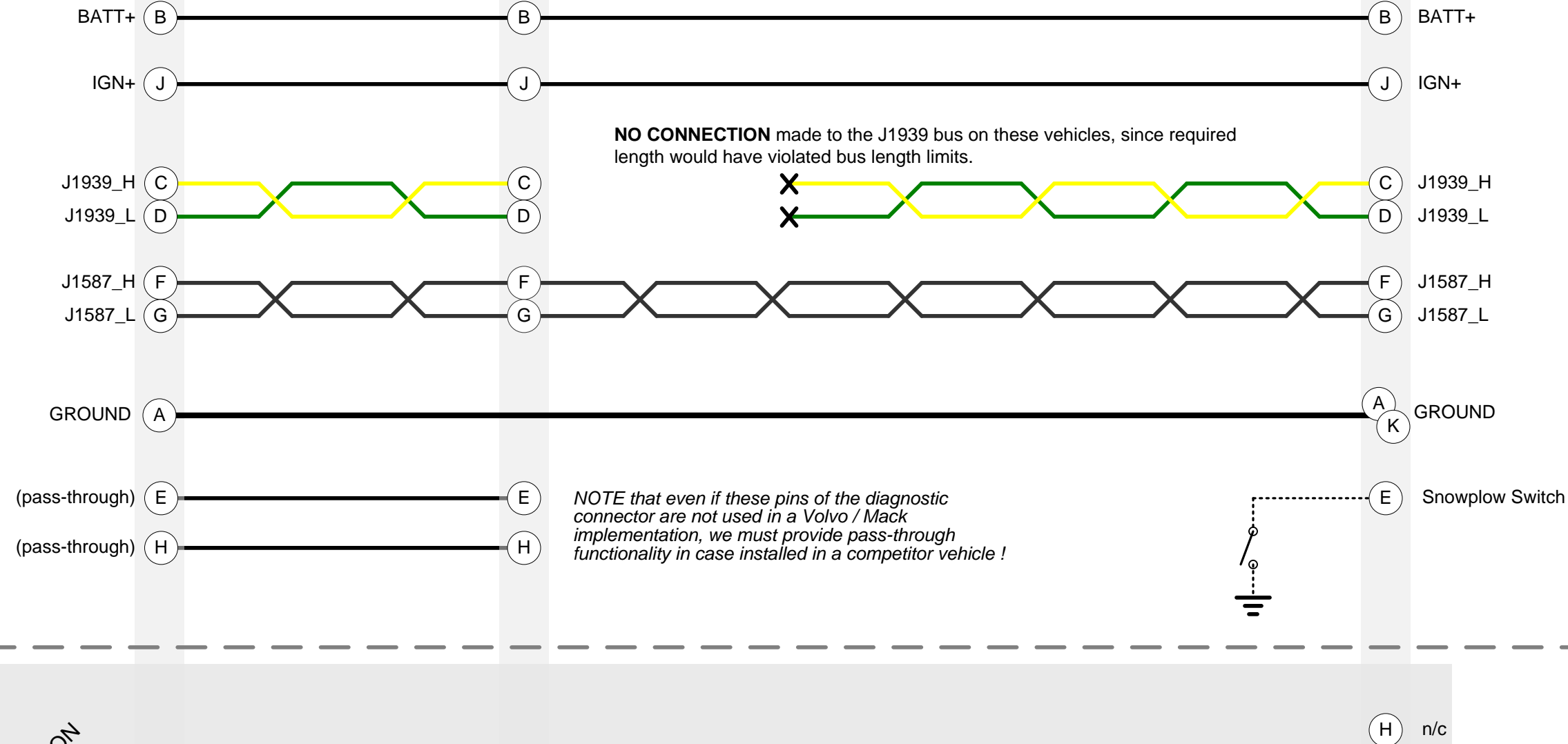

NO CONNECTION

Connection to MACK-brand vehicles is made via connection to body-builder terminal strip under-dash

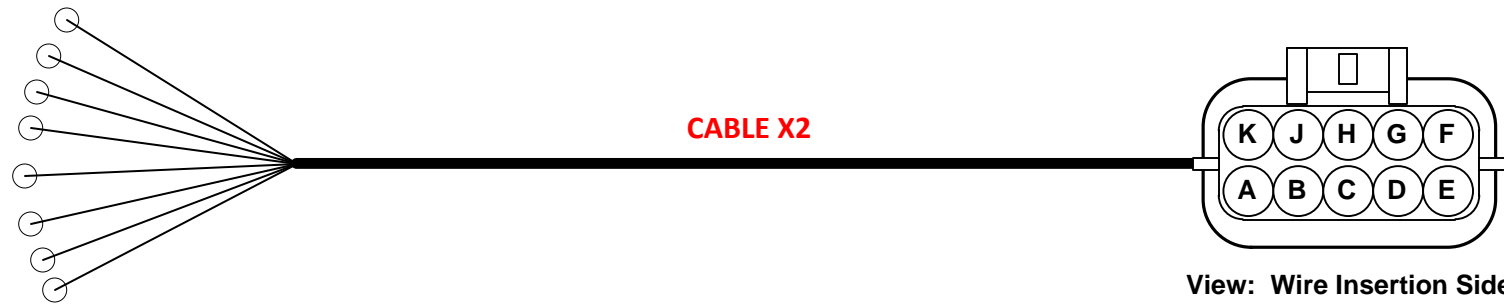

M/P 150-series 10-way
Female Terminals / Male Body

Housing: 12065425 (1 per)
Terminals: 12048074 (10 per)
Seals: 12048086 (10 per)
TPA: 12124264 (1 per)

○ = Ring terminals suitable for #10 stud

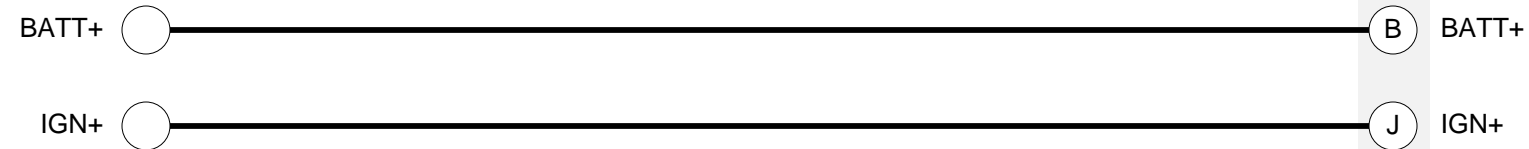

Plugs into J1939 backbone extension under dash (after removing existing J1939 Term. Res.)

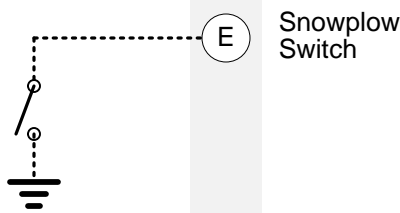
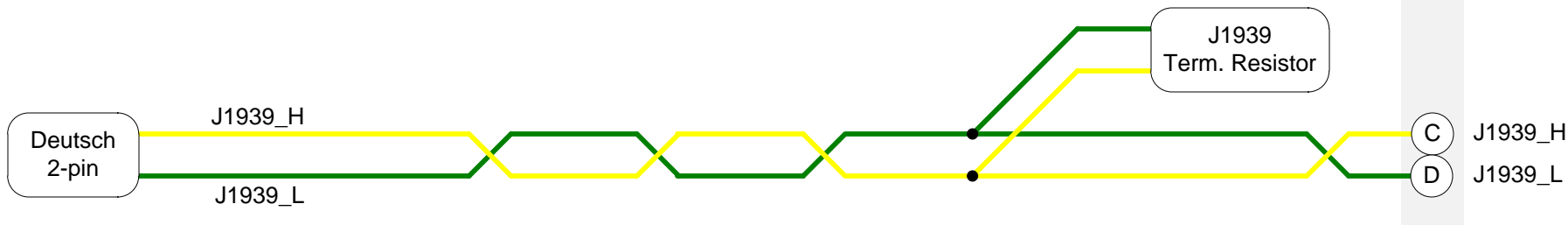

Mates to CABLE Y

NO CONNECTION

(H) n/c

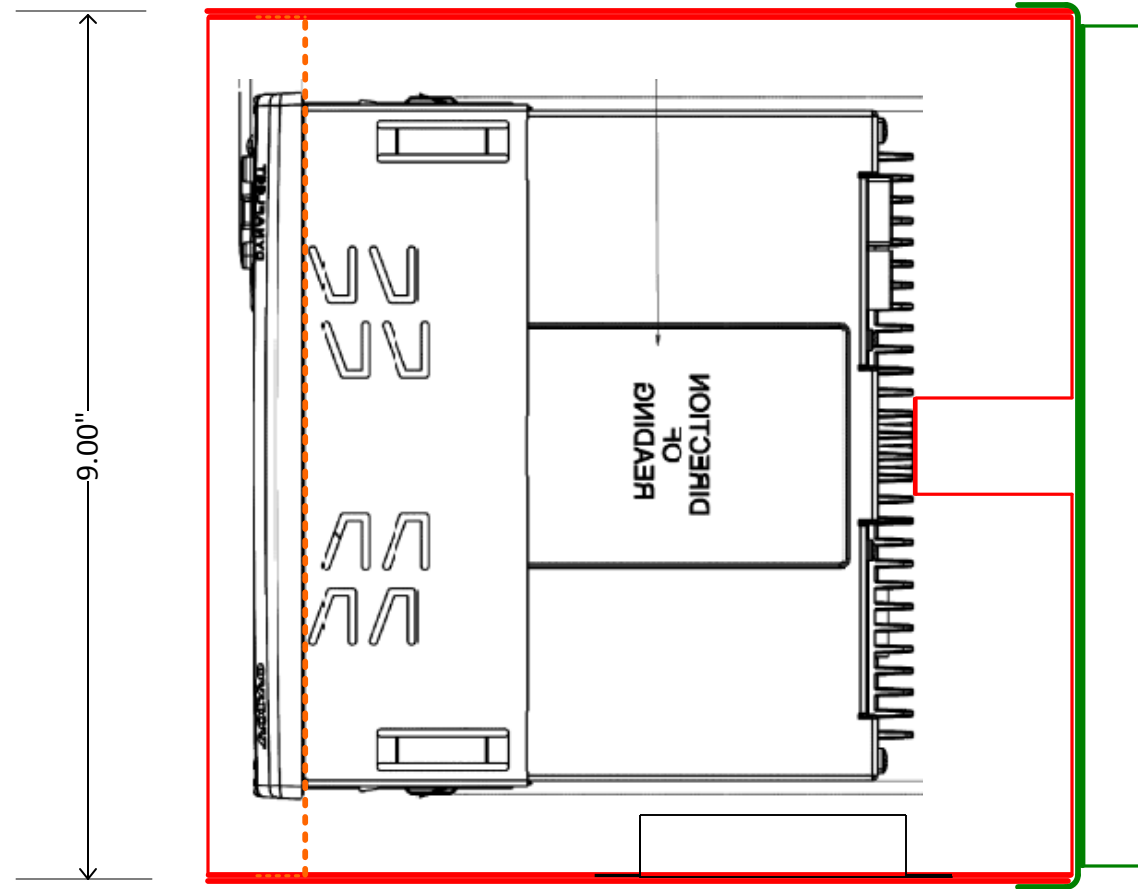
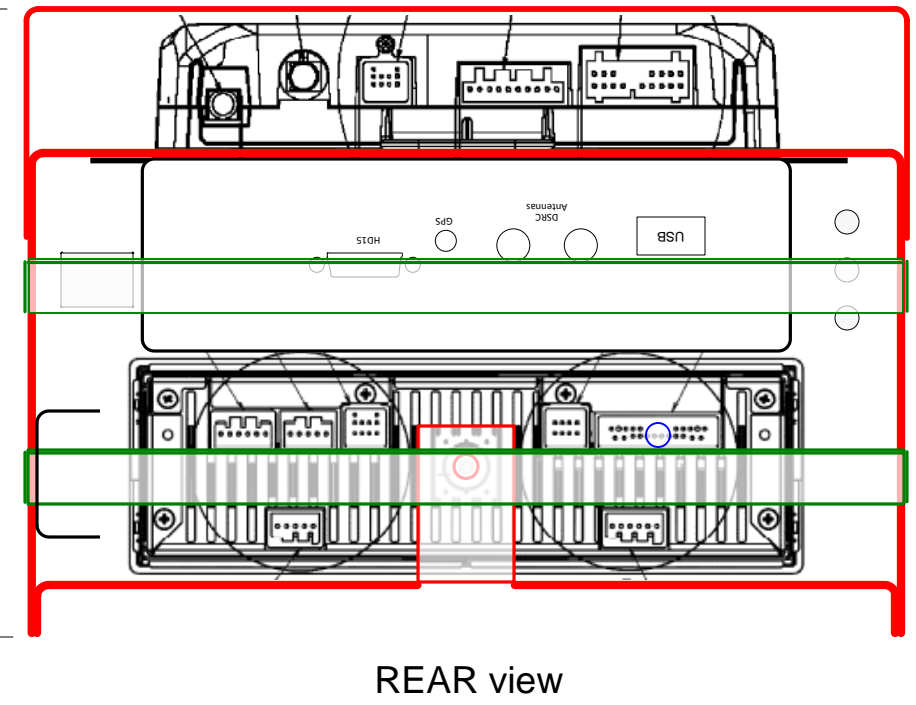
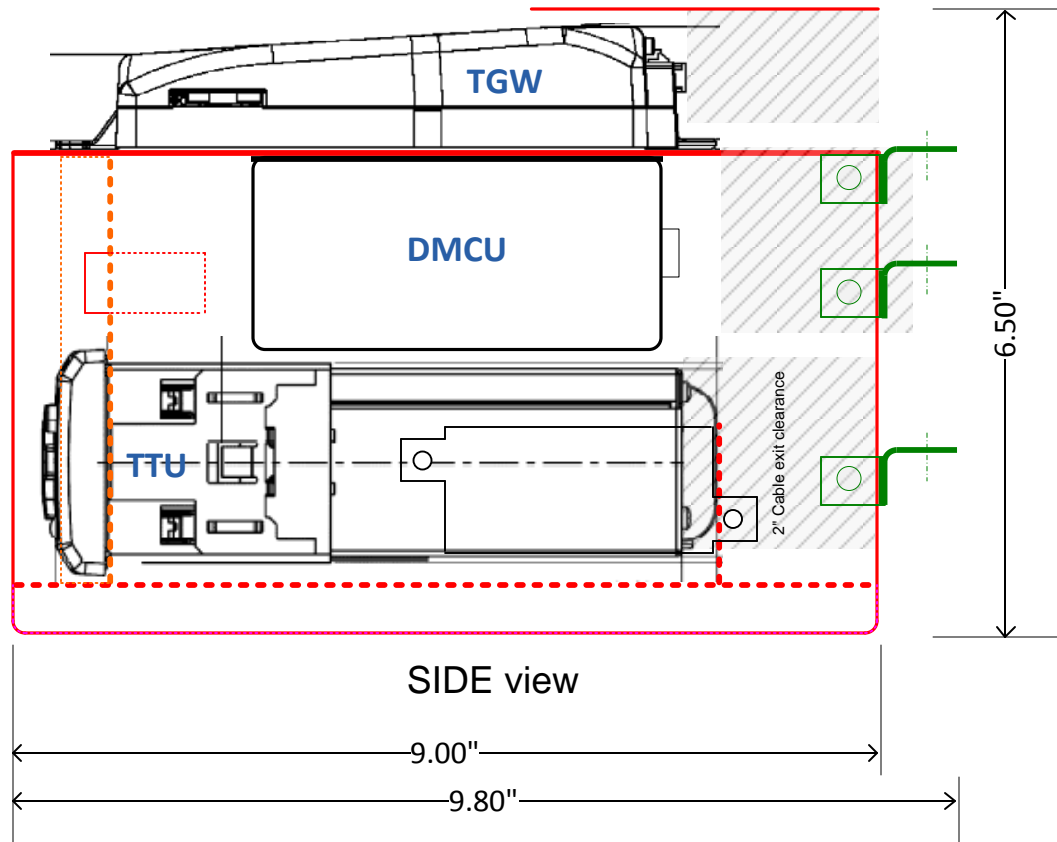
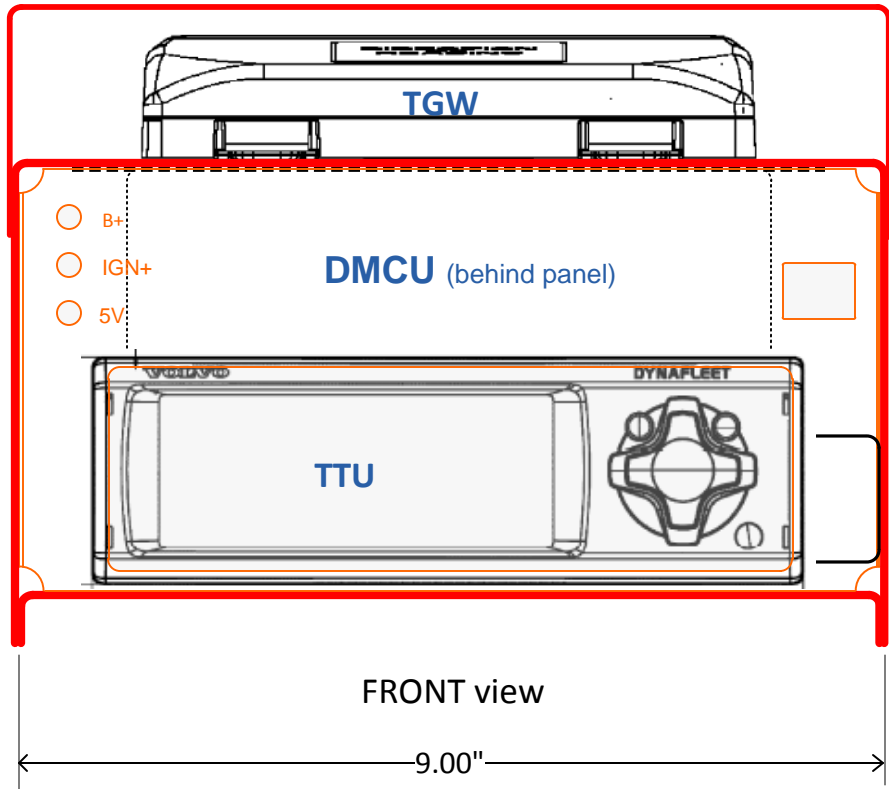

Material: 0.045" sheet metal

SCALE: 1/2" = 1.0"

DO NOT SCALE FROM PRINTOUT!

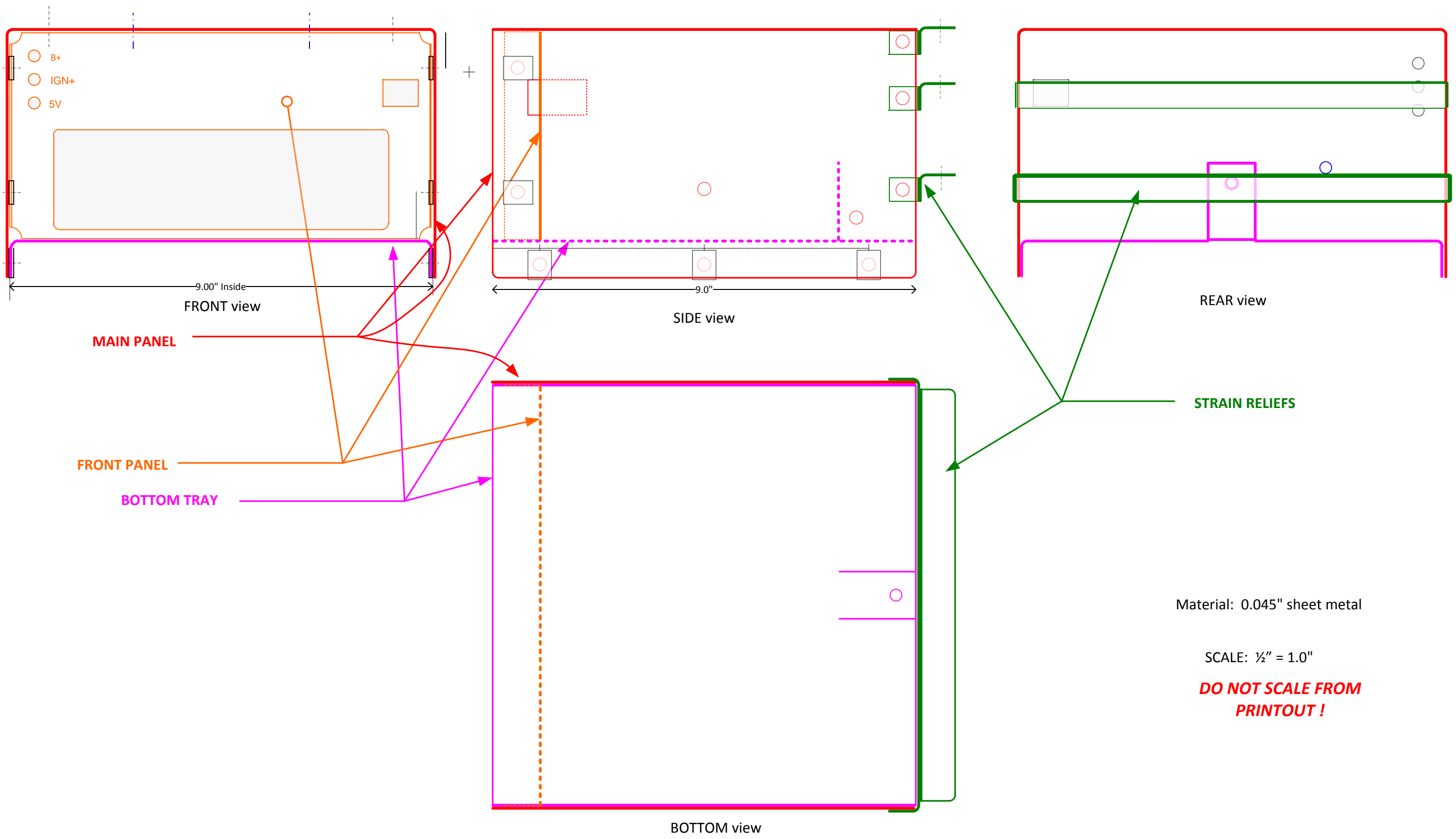

- B+
- IGN+
- 5V

9.00" Inside
FRONT view

9.0"
SIDE view

REAR view

BOTTOM view

MAIN PANEL

FRONT PANEL

BOTTOM TRAY

STRAIN RELIEFS

Material: 0.045" sheet metal

SCALE: 1/2" = 1.0"

**DO NOT SCALE FROM
PRINTOUT !**

Description	Qty	Manufacturer	Part Number	Est Cost
DSRC Mobile Communications Unit (DMCU)	1	Kapsch	MCU-01	\$3,000
Telematics Gateway (TGW)	1	Volvo	21284312	\$300
Telematics Terminal Unit (TTU)	1	Volvo	21034575	\$300
VGA Display	1	Xenarc	700TSV	\$350
Cable – Display <> VGA Connector	1	Xenarc	[Included w/700TSV]	- - -
OBE Enclosure	1	Volvo	6980-02941-01-26 [6-7]	\$700
Cable Harness – DMCU <> TGW <> TTU	1	Volvo	6980-02941-01-26 [3]	\$1150
Cable Harness – Vehicle Interface	1	Volvo	6980-02941-01-26 [4/5]	\$500
Cable Harness – TTU <> VGA Display	1	Volvo	6980-02941-01-26 [2]	\$350
Cable – TTU <> Display Unit	1	Volvo	21082015	\$50
Cable – TGW <> TTU (Mitsumi USB)	1	Volvo	20885519	\$15
Cable – Antenna Extension – GPS + SM (2.2 m)	1	Volvo	21385255	\$10
Power Supply (DC to DC)	1	Opus Solutions	DCL11-5V	\$50
DSRC Antenna	2	Mobile Mark	ECOM9-5500	\$250
GPS Antenna	1	ACC	GPS-P1MAL	\$25
GSM/GPS Antenna	1	Hirschmann	HCEL-AG-0104A-02	\$50
TIS Keypad	1	Volvo	20375500	\$30

